

# **MASSAGE CHAIR**

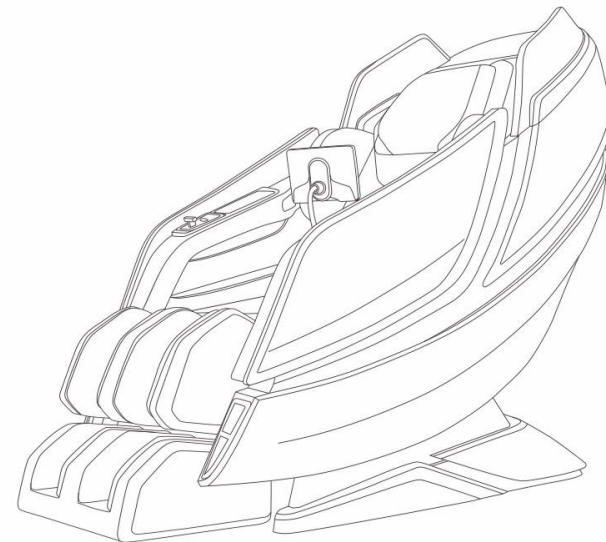

**MODEL: SUMMIT**

## CONTENTS

Please read and follow all safety and operating instructions listed in this user manual prior to use. Basic precautions should always be used when operating.

Safety Instructions	-----2-3
Product Specifications	-----4
Product Components	-----5-6
Chair Installation	-----7-10
Before Use	-----11
Instructions	-----12-20
Trouble Shooting	-----21
Maintenance	-----22

Note: Our company reserves the right to revise the design and description of this product without any further notice.

## MAINTENANCE

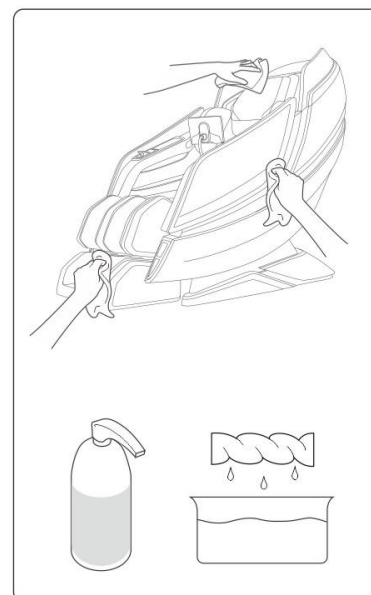

- Turn off and pull out the plug before clean the massage chair, do not touch the plug with wet hands.

- Use dry cloth to wipe sweat and other besmirch.

- Besmirch is serious, please use neutral wash to wipe and lightly brush the massage chair.

- Please airing.

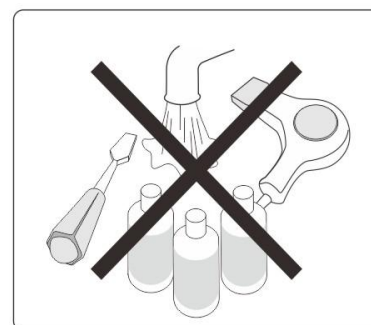

- Prohibit to use water to clean the chair.

- Do not dry the chair with roaster.

- Prohit to use alcohol, benzene wash etc.

## TROUBLE SHOOTING

In case of mal-function or emergence of abnormalities, stop using the massage chair and un-plug from the power source. Try the following methods to resolve the problem. If the problem persists contact the service agent immediately.

Abnormalities	Possible solutions
Make a sound when running.	The sound of the structural design will not affect the chair.
There is power supply but the massage chair is not working.	1-Check the power connection to the chair, make sure it is fully connected. 2. Check whether the power switch at the rear of the massage chair is lighted up("I"position).
Massage chair is not responding to the control panel selection.	After prolonged usage the thermostate installed in the massage chair will be activated to prevent over-heating. Turn off all the power key and switches, let the massage chair cool down for 30 minutes before re-activate it.
Both the control panel and the massage chair are not working.	The pre-set timing massage duration is up therefore auto-lock has been activated. Re-set the time to start the operation again.

## SAFETY INSTRUCTIONS

### Warning

The plug must be fully inserted into an appropriate outlet. Improper connection of the equipment-grounding conductor can result in the risk of electric shock. Check with a qualified electrician or service technician, if you are in doubt as to whether the product is properly grounded. Do not modify the plug provided with the product if the outlet is not suitable. Please ensure that a proper outlet is installed by a qualified electrician. When using the massage chair, basic precautions should always be followed to reduce the risk of electric shock, burns, fire, or injury to person.

1. Please ensure that you plug the massage chair into a proper electrical outlet.
2. Make sure the power plug is securely inserted into the proper electrical outlet to reduce the risk of short-circuit and fire.
3. Always unplug the massage chair from the electrical outlet immediately after use and before cleaning.
4. Do not use the massage chair in places where the humidity is high.
5. Do not use the massage chair outdoors and avoid place with direct sunlight.
6. If the power goes off during use, be sure to turn the power switch to the off position and pull the power plug out from the socket to prevent damage from occurring when the power is restored.
7. Never operate the massage chair if the power cord is wet or damaged.
8. Never plug/unplug the power cord from the socket with wet hands.
9. Close and continuous supervision is necessary when this appliance is being used by on or near children, invalid or disabled person.
10. Use this appliance only for its intended use as described in this use manual.
11. Do not use any parts not from factory.
12. Do not stand, sit or jump in the calves rest when massage chair is in use to prevent any injury to person.
13. Do not attempt to stand on the backrest and armrest to prevent any injury to person.
14. Be careful not to fall asleep during the massage session.
15. Always keep the massage chair clean and never insert any object into the gaps on and around the massage chair.
16. Do not move the massage chair by pulling the power supply cord.
17. Always check whether the surface of the massage chair is torn or ripped before usage, if you found any unfamiliar rips in any area of the cloth in the backrest, do not use the massage chair, kindly contact the service centre immediately for repair.
18. This appliance is designed for household use only.
19. For those suffering from illnesses, please consult your doctor for advice prior to use.

## SAFETY INSTRUCTIONS

20. The following persons are requested to consult a doctor prior to use in order to reduce the risk of user feeling sick or suffering from injury
- Those who have malignant tumor
  - Those who suffer from heart disease
  - Those who are experiencing pregnancy, menstruation and puerperal fever
  - Those who require complete rest
  - Those who are under medical treatment
  - Those who suffer from back problem or whose backbone is abnormal or bent
  - Those who have osteoporosis
21. If you experience pain during usage, stop using the massage chair immediately, if any injuries occur, seek medical treatment immediately.
22. Never massage the swollen or inflamed parts of the body.
23. This product is non-professional appliance designed to provide a comfortable massage. do not use this product as substitute for medical treatment.
24. Each massage session should not exceed 30 minutes. massage the targeted area only for 15mins, over-massaging can lead to overheating, thus giving the appliance a shorter lifespan.
25. Do not operate where aerosol(spray) product are used or where oxygen is being administered.
26. The massage chair is not suitable for children aged 14 and below.

### NOTE:

- This appliance is not intended for use by persons(including children) with reduced physical sensory or mental capabilities, or lack of experience and knowledge, unless they have been given supervision or instruction concerning use of the appliance by a person responsible for their safety.
- If the supply cord is damaged, it must be replaced by manufacturer, its service agent or similarly qualified persons in order to avoid a hazard.
- The appliance heats up during operation. persons sensitive to heat must take extra caution when using the appliance.

## INSTRUCTIONS

### 10. The method of playing the bluetooth music in massage chair

A: Match: Open the bluetooth function in mobile phone or Ipad, and search nearby. choose the massage chair bluetooth function music equipment and match with it.

B: Play music: After matching with it, you can display the music by mobile or APP music display software.

#### Attention:

Please off the bluetooth connection when not in use so as for other devices to connect smoothly.

### 11. After massage

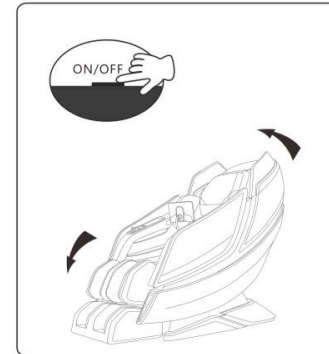

1. After massage press the on/off button to return the chair to its original position.

\*Ensure nothing is obstructing the chair from returning to its original position.

2. Press the power switch of the control panel to shut down all the functions.
3. Press the power switch to off to cut off power supply.

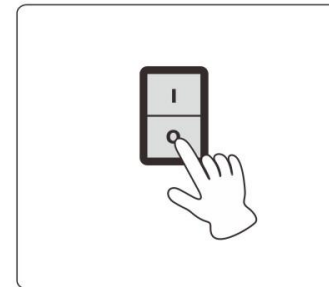

4. Unplug from the wall socket.

\* Power switch located the rear of the massage chair

# INSTRUCTIONS

## 8. Sitting adjustment

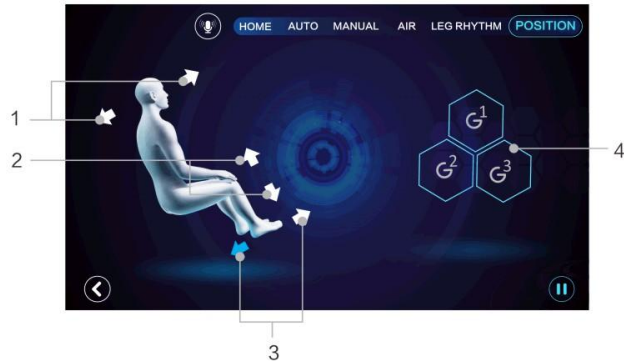

1. Backrest down and up
2. Legrest extend
3. Footrest raised and lowered
4. Zero-gravity position area: three levels option

## 9. Voice



Press the "Voice ON" key; say the words as shown in the picture; Then the chair will activate the corresponding massage service.

# PRODUCT SPECIFICATIONS

Description	Specifications
Product Name	MASSAGE CHAIR
Model No.	SUMMIT
Rated Voltage	110-240V~
Rated Frequency	50-60Hz
Rated Power Consumption	180W
Product Size	1590(L)x880(W)x1320(H)mm
Carton Size	Main body: 1480(L)x766(W)x885(H)mm
	Side panel: 1820(L)x505(W)x815(H)mm
	Legrest: 580(L)x505(W)x630(H)mm
Weight	Main body: N.W.: 68.5kg G.W.:87kg
	Side panel: N.W.: 27kg G.W.:36kg
	Legrest: N.W.: 21kg G.W.:24kg

# PRODUCT COMPONENTS

## Main Body Diagram

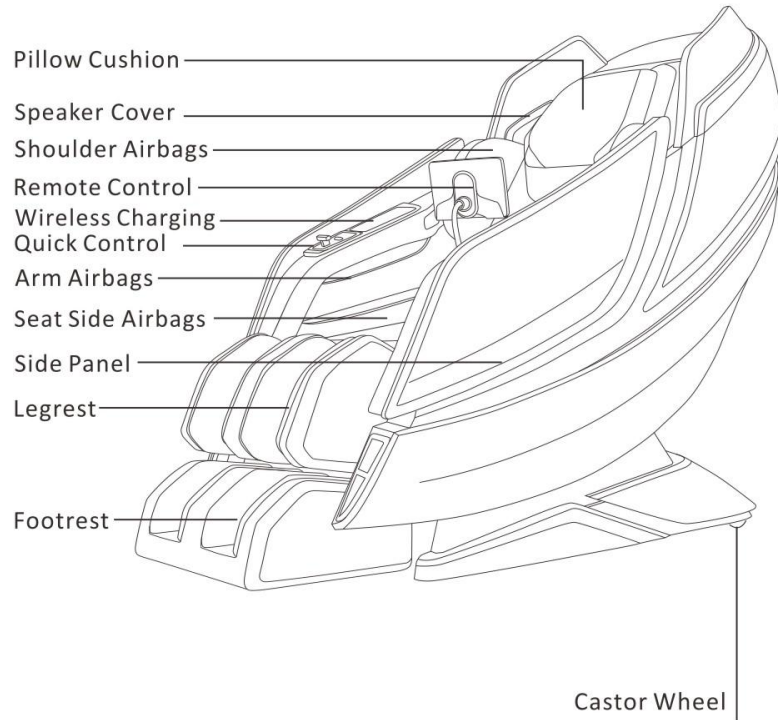

# INSTRUCTIONS

## 6. Airbags massage



- 1. Airbag massage intensity adjustment area
- 2. Airbag massage area display
- 3. Airbag massage area selection area
- 4. Return
- 5. Heating area selection area
- 6. Selection area of sole roller part
- 7. Pause

## 7. Leg vibration

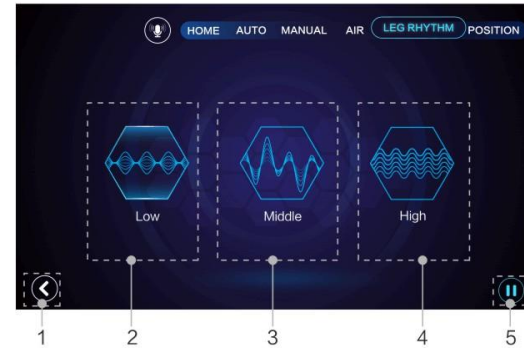

- 1. Return
- 2. Slow speed vibration
- 3. Gentle speed vibration
- 4. Quick speed vibration
- 5. Pause

# INSTRUCTIONS

## 5. Manual modes

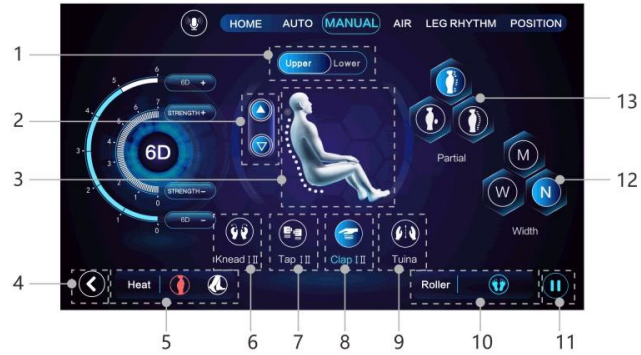

- 1.Manual massage of the upper or lower body
- 2.Adjustment of the up and down position of the massage movement
- 3.Massage movement area display
- 4.Return
- 5.Heating site selection
- 6.Kneading massage(2 levels adjustable)
- 7.Tapping massage(2 levels adjustable)
- 8.Clapping massage(2 levels adjustable)
- 9.Tuina Massage
- 10.Selection area of sole roller part
- 11.Pause
- 12.Massage width adjustment area(not effective when kneading is on)
- 13.Massage interval adjustment area

# PRODUCT COMPONENTS

## Main Body Diagram

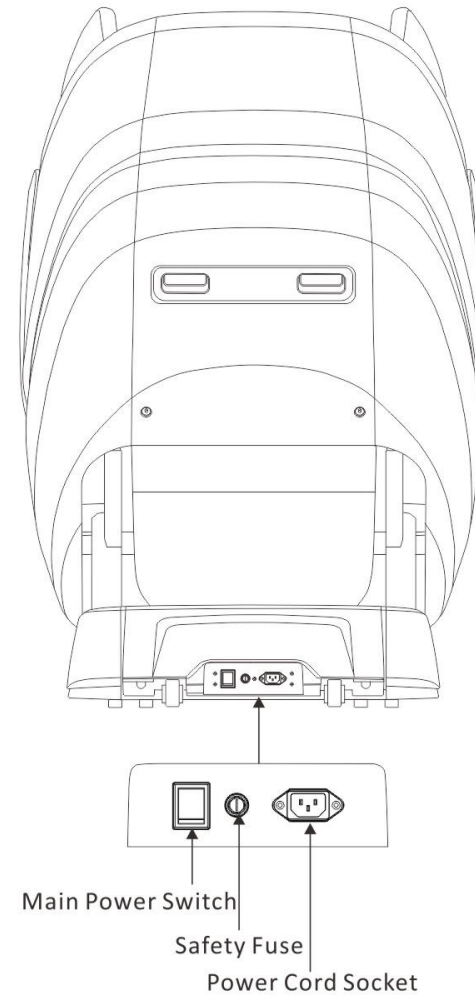

# CHAIR INSTALLATION

## (1) Open carton and take out accessories

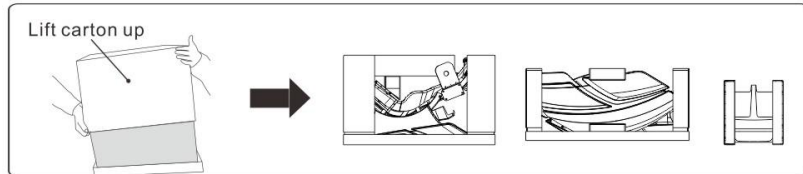

1. Cut off the plastic belt on carton, then lift the carton up and move it away
2. Take out the accessories of massage chair
3. Put the plug to electrical socket, then turn on massage chair, let it reset to original position.

**Note: Unplug the power after reset.**

## (2) Installation steps

The accessories for installation as following:



### 1. Install side panels

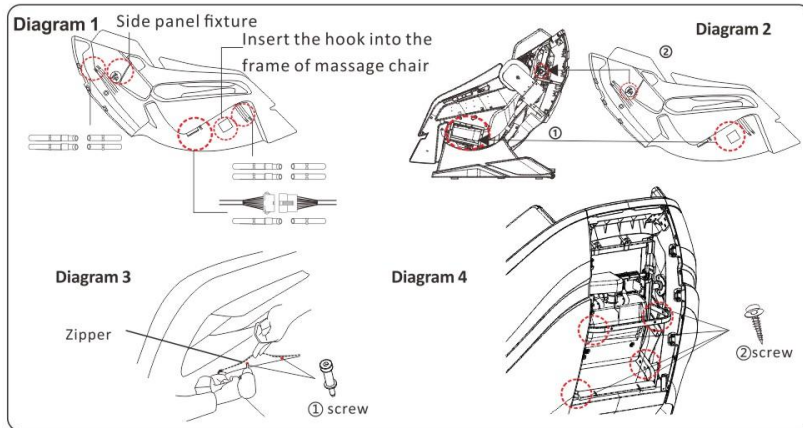

# INSTRUCTIONS

## 4. Detection

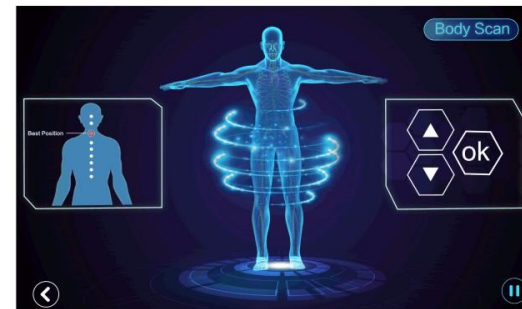

1. Press any of the automatic modes, the latest smart body detection will be turned on (only automatically detected once after booting).
2. After the inspection is completed, within 8 seconds, the user can choose to fine-tune the shoulder position according to his needs. You can also press OK directly to confirm the shoulder position.

# INSTRUCTIONS

## 3. Auto modes

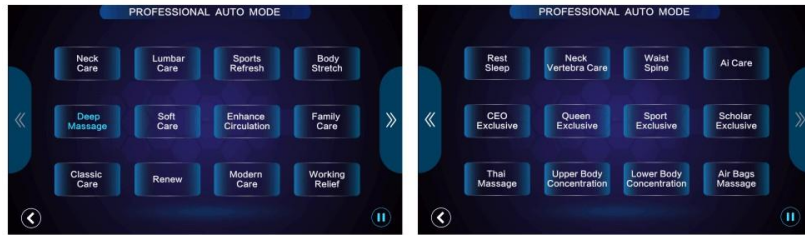

There are 24 kinds of all-round unique automatic massage modes in the corresponding massage area.

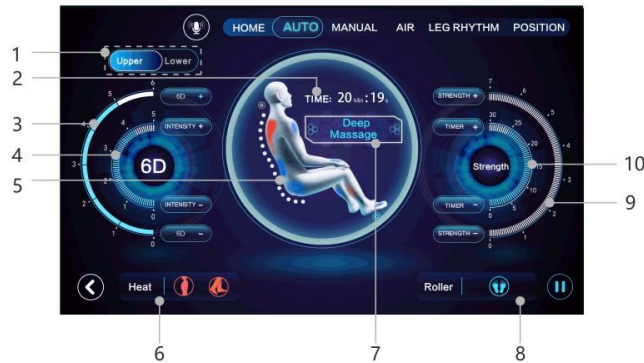

1. Manual massage of the upper or lower body
2. Display the remaining massage time
3. 6D massage intensity adjustment area
4. Airbags intensity adjustment zone
5. Movement/airbag/heating/roller massage area display
6. Heating site selection
7. Automatic program name display
8. Sole roller location selection
9. Movement speed/strength adjustment
10. Massage time adjust

Statement: Dual movement operation rules follow the lower movement to avoid the upper movement operation when the distance between the two movements triggers anti-collision safety logic, the lower movement will give priority to traveling down to avoid a crash with the upper movement, so it will be a little different from the set mode of operation, it is a normal phenomenon.

# CHAIR INSTALLATION

1. Connect the air pipes and wire connector by same color match, refer to diagram 1
2. Insert the hook into the frame of massage chair, refer to ① ② in Diagram 2
3. Unzip the zipper of side panel and find two screw holes, and tighten screws the screw holes, refer to diagram 3
4. The right side panel installation method same as the left side panel except for right side panel less two air pipes and a separate air pipe connector
5. After fix the both left and right side panels, tighten all screws in pointed position, refer to diagram 4

## 2. Install the decoration plastic bar onto head cover

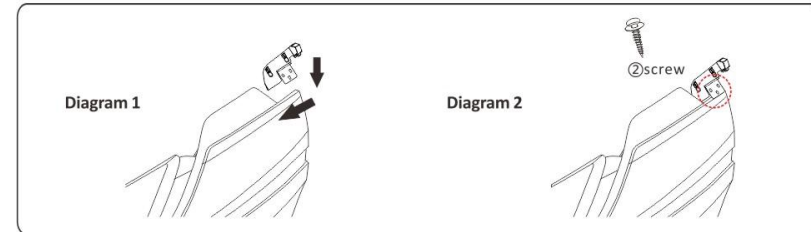

1. Install the decoration plastic bar onto head cover
2. Put the head cover on the appointed position, push forward, refer to diagram 1, and then put the decoration plastic bar on side panel fixture position
3. Tighten ② screws on both side panels position

## 3. Install back cover

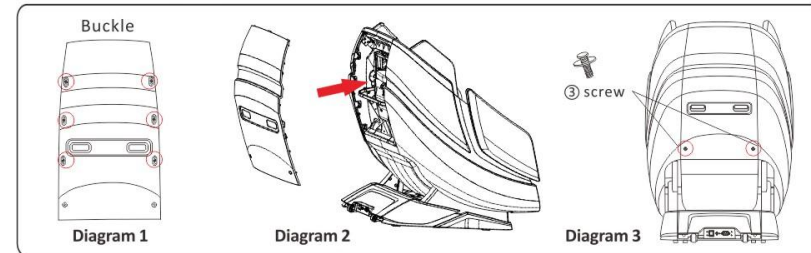

1. Put back cover onto massage chair, then slightly tap the back cover to let the buckles match each other
2. Tighten ③ screws into the pointed positions, refer to diagram 3

# CHAIR INSTALLATION

# INSTRUCTIONS

## 4. Installation of legrest unit

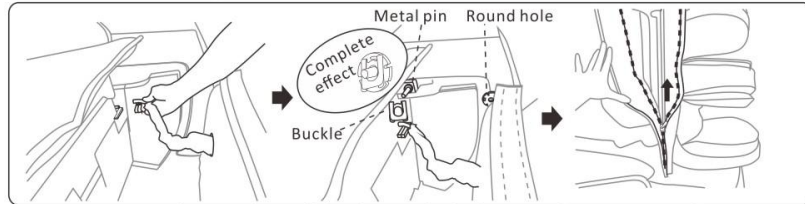

1. First connect the trachea of the leg with the bus on the massage chair.
2. Lift the leg and insert the round hole in the upper right corner of the leg into the metal pin shaft of the massage chair, and then insert it with a buckle to fix it.
3. When installing the left side, first move the whole leg to the right, align the round hole in the upper left corner and the pin of the massage chair, move the lower leg to the left, and then insert the buckle to fix it.
4. Pull the holster on the leg to the zipper of the massage chair.
5. Finish the leather case.

## 5. Install remote controller holder

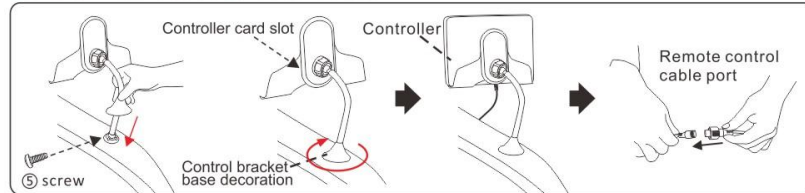

1. Align the holes of the hand control bracket with the mounting holes of the bracket base on the armrest, then lock the No. 5 screw into the hole to fix the bracket, and finally push the hand control bracket base decoration down to the bracket base, and finally press turn the buckle clockwise to secure.
2. When the pad controller is clicked into the controller bracket, a "click" sound is heard before it is completely fixed.
3. Then dock the pad controller cable with the connector on the massage chair.

## 6. Install backrest

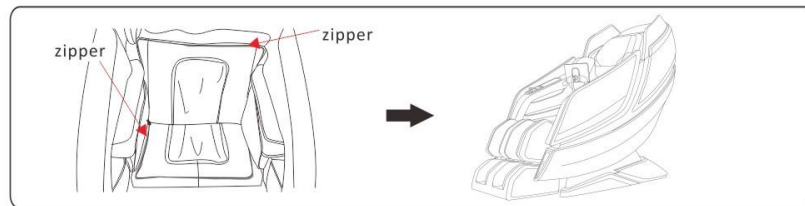

1. Open the backrest and zip the zippers onto massage chair
2. The installation is done

9

## 1. Remote controller interface and description

- Open the remote controller and the main menu will be displayed. Please select the program you want.



- |                         |                  |                   |
|-------------------------|------------------|-------------------|
| 1. Renew                | 2. Manual modes  | 3. Airbag massage |
| 4. Return               | 5. Pause         | 6. Settings       |
| 7. More automatic modes | 8. Deep masaasge |                   |

## 2. Settings

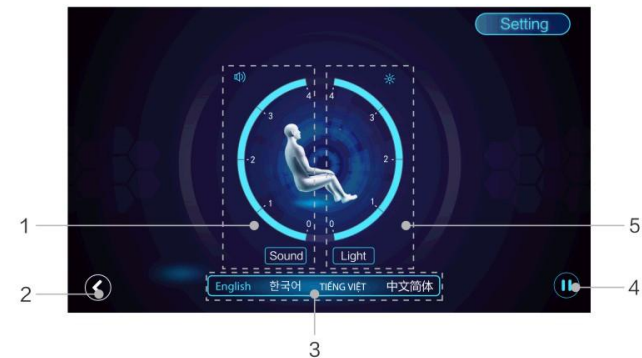

- |                          |                                      |                        |
|--------------------------|--------------------------------------|------------------------|
| 1. Sound adjustment area | 2. Return                            | 3. Languages selection |
| 4. Pause                 | 5. Screen brightness adjustment area |                        |

14

# INSTRUCTIONS

## Remote Controller



# CHAIR INSTALLATION

## (3) Place the massage chair in an open area

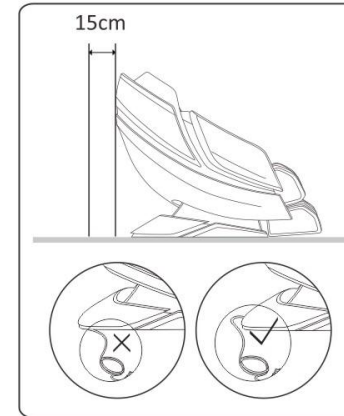

- Allow sufficient space around the chair for recline purposes.  
15cm distance for the back side and 40cm in front of the footrest.

- \*In order to avoid the damage of the floor and to reduce the noise, please put area rug under the massage chair.
- \*Make sure that there are no barriers in front and the back of the massage chair.
- \*Please do not put it in wet or uneven floor.
- \*To avoid signal interference, please place it 4 feet away from AV,TV, and radio.

**Warning:**  
Do not put the power cord under of relax chair!

## (4) Moving the massage chair

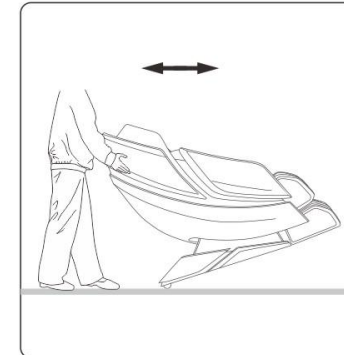

As illustrated, push the backrest downwards and tilt chair on to its wheels at a 45° angle. Slowly push and maneuver the massage chair to desired location. Lower massage chair slowly and smoothly until it is fully flat on the ground.

- CAUTION:**
- \*Do not move massage chair when occupied or in use.
  - \*Moving the massage chair may cause damage to the floors. Floor protection is recommended (e.g. rugs or carpet).
  - \*Do not drop or suddenly let go of the chair when moving as it may damage the chair.
  - \*Two persons are recommended when moving and extra care when handling the massage chair.

## BEFORE USE

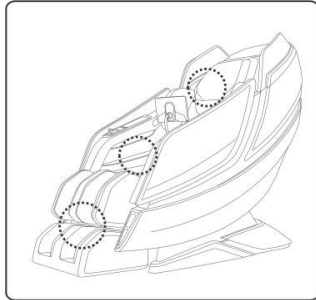

- 1. Make sure the product is in good condition and proper working order.**
  - Check the headrest and backrest pad.
  - Inspect the power plug.
  - Make sure the footrest is in its upright original position in order to prevent damage.

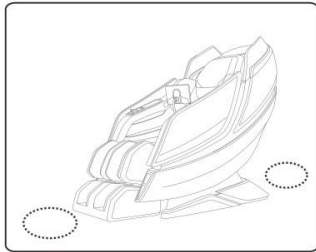

- 2. Check the surrounding environment**
  - Ensure there are no people, pets, or objects obstructing the massage chair.

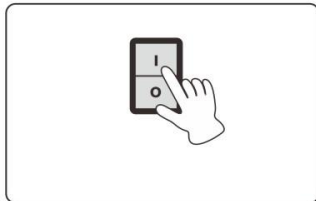

- 3. Plug in the massage chair power cord.**
  - Connect the power cord.
  - Turn ON the power switch, located on the right side of the massage chair.

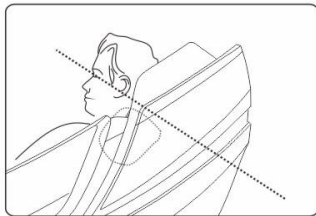

- 4. Adjust the position of the headrest.**
  - Adjust the headrest until it is in a comfortable position.

## INSTRUCTIONS

### Quick Control

